

Engineering Drawing (mm)

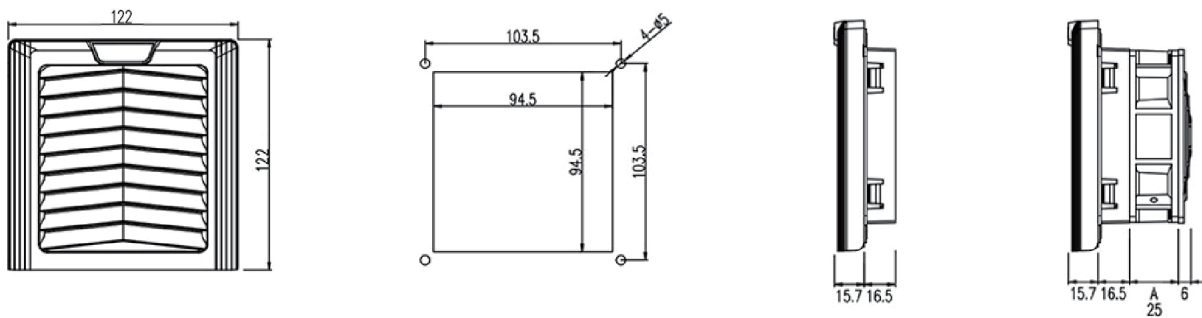

Specifications

Model No. (Filter fan unit)	GX95.230	GX95.115	GX95.024
Rated operating voltage	220 ~ 240V	110 ~ 120V	24V
Frequency	50/60 Hz	50/60 Hz	/
Air flow rate (Free blow)	25/35 m ³ /h		35 m ³ /h
Air flow rate with filter	1 x GX95.300:20/25 m ³ /h		
Axial fan	Self starting shaded pole motor		
Max. rated current	0.07A / 0.06A	0.14A / 0.13A	0.18A
Rated Power	13/12W		4.3W
Noise level	32/35 dB(A)		35 dB(A)
Operating temperature range	-30°C ~ 70°C		
Model No. (Exit filter)	GX95.300		
Optional Fan Size	1) 92x92x25mm; 2) 92x92x38mm		
Material	ABS; ABS plastic with UL 94V-0 as customized option		
Air flow direction	Air-in as default; air-out optional		
Protection Level	IP54		